

LOW POWER SIX-CHANNEL DIGITAL ISOLATOR

Features

- High-speed operation
 - DC to 150 Mbps
- No start-up initialization required
- Wide Operating Supply Voltage
 - 2.5–5.5 V
- Up to 5000 V_{RMS} isolation
- 60-year life at rated working voltage
- High electromagnetic immunity
- Ultra low power (typical) 5 V Operation
 - 1.6 mA per channel at 1 Mbps
 - 5.5 mA per channel at 100 Mbps
- 2.5 V Operation
 - 1.5 mA per channel at 1 Mbps
 - 3.5 mA per channel at 100 Mbps
- Schmitt trigger inputs
- Selectable fail-safe mode
 - Default high or low output (ordering option)
- Precise timing (typical)
 - 10 ns propagation delay
 - 1.5 ns pulse width distortion
 - 0.5 ns channel-channel skew
 - 2 ns propagation delay skew
 - 5 ns minimum pulse width
- Transient Immunity 50 kV/μs
- AEC-Q100 qualification
- Wide temperature range
 - –40 to 125 °C
- RoHS-compliant packages
 - SOIC-16 wide body
 - SOIC-16 narrow body

Applications

- Industrial automation systems
- Medical electronics
- Hybrid electric vehicles
- Isolated switch mode supplies
- Isolated ADC, DAC
- Motor control
- Power inverters
- Communication systems

Safety Regulatory Approvals

- UL 1577 recognized
 - Up to 5000 V_{RMS} for 1 minute
- CSA component notice 5A approval
 - IEC 60950-1, 61010-1, 60601-1 (reinforced insulation)
- VDE certification conformity
 - IEC 60747-5-2 (VDE0884 Part 2)
 - EN60950-1 (reinforced insulation)
- CQC certification approval
 - GB4943.1

Description

Silicon Lab's family of ultra-low-power digital isolators are CMOS devices offering substantial data rate, propagation delay, power, size, reliability, and external BOM advantages over legacy isolation technologies. The operating parameters of these products remain stable across wide temperature ranges and throughout device service life for ease of design and highly uniform performance. All device versions have Schmitt trigger inputs for high noise immunity and only require VDD bypass capacitors.

Data rates up to 150 Mbps are supported, and all devices achieve propagation delays of less than 10 ns. Ordering options include a choice of isolation ratings (2.5, 3.75 and 5 kV) and a selectable fail-safe operating mode to control the default output state during power loss. All products >1 kV_{RMS} are safety certified by UL, CSA, VDE, and CQC, and products in wide-body packages support reinforced insulation withstanding up to 5 kV_{RMS}.

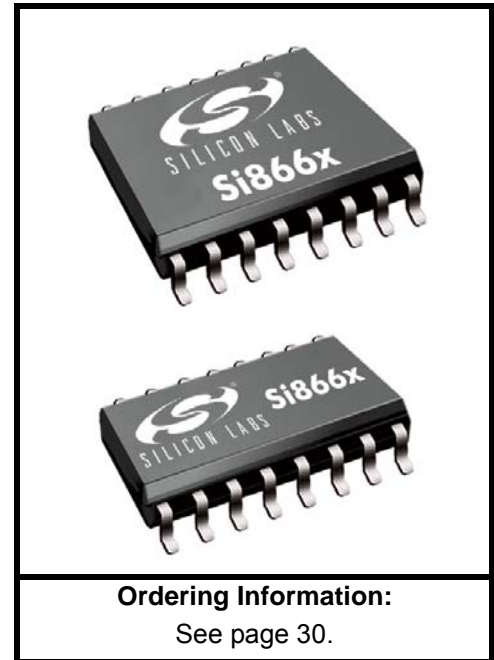

TABLE OF CONTENTS

<u>Section</u>	<u>Page</u>
1. Electrical Specifications	4
2. Functional Description	22
2.1. Theory of Operation	22
2.2. Eye Diagram	23
3. Device Operation	24
3.1. Device Startup	25
3.2. Undervoltage Lockout	25
3.3. Layout Recommendations	26
3.4. Fail-Safe Operating Mode	26
3.5. Typical Performance Characteristics	27
4. Pin Descriptions	29
5. Ordering Guide	30
6. Package Outline: 16-Pin Wide Body SOIC	31
7. Land Pattern: 16-Pin Wide-Body SOIC	33
8. Package Outline: 16-Pin Narrow Body SOIC	34
9. Land Pattern: 16-Pin Narrow Body SOIC	36
10. Top Markings	37
10.1. Si866x Top Marking (16-Pin Wide Body SOIC)	37
10.2. Top Marking Explanation (16-Pin Wide Body SOIC)	37
10.3. Si866x Top Marking (16-Pin Narrow Body SOIC)	38
10.4. Top Marking Explanation (16-Pin Narrow Body SOIC)	38
Document Change List	39
Contact Information	40

Si8660/61/62/63

1. Electrical Specifications

Table 1. Recommended Operating Conditions

Parameter	Symbol	Min	Typ	Max	Unit
Ambient Operating Temperature*	T_A	-40	25	125	°C
Supply Voltage	V_{DD1}	2.5	—	5.5	V
	V_{DD2}	2.5	—	5.5	V

*Note: The maximum ambient temperature is dependent on data frequency, output loading, number of operating channels, and supply voltage.

Table 2. Electrical Characteristics

($V_{DD1} = 5\text{ V} \pm 10\%$, $V_{DD2} = 5\text{ V} \pm 10\%$, $T_A = -40$ to $125\text{ }^\circ\text{C}$)

Parameter	Symbol	Test Condition	Min	Typ	Max	Unit
VDD Undervoltage Threshold	V_{DDUV+}	V_{DD1}, V_{DD2} rising	1.95	2.24	2.375	V
VDD Undervoltage Threshold	V_{DDUV-}	V_{DD1}, V_{DD2} falling	1.88	2.16	2.325	V
VDD Undervoltage Hysteresis	V_{DDHYS}		50	70	95	mV
Positive-Going Input Threshold	V_{T+}	All inputs rising	1.4	1.67	1.9	V
Negative-Going Input Threshold	V_{T-}	All inputs falling	1.0	1.23	1.4	V
Input Hysteresis	V_{HYS}		0.38	0.44	0.50	V
High Level Input Voltage	V_{IH}		2.0	—	—	V
Low Level Input Voltage	V_{IL}		—	—	0.8	V
High Level Output Voltage	V_{OH}	$I_{OH} = -4\text{ mA}$	$V_{DD1}, V_{DD2} - 0.4$	4.8	—	V
Low Level Output Voltage	V_{OL}	$I_{OL} = 4\text{ mA}$	—	0.2	0.4	V
Input Leakage Current	I_L		—	—	± 10	μA
Output Impedance ¹	Z_O		—	50	—	Ω

Notes:

1. The nominal output impedance of an isolator driver channel is approximately $50\ \Omega$, $\pm 40\%$, which is a combination of the value of the on-chip series termination resistor and channel resistance of the output driver FET. When driving loads where transmission line effects will be a factor, output pins should be appropriately terminated with controlled impedance PCB traces.
2. $t_{PSK(P-P)}$ is the magnitude of the difference in propagation delay times measured between different units operating at the same supply voltages, load, and ambient temperature.
3. Start-up time is the time period from the application of power to valid data at the output.

Table 2. Electrical Characteristics (Continued) $(V_{DD1} = 5\text{ V} \pm 10\%, V_{DD2} = 5\text{ V} \pm 10\%, T_A = -40\text{ to }125\text{ }^\circ\text{C})$

Parameter	Symbol	Test Condition	Min	Typ	Max	Unit
DC Supply Current (All inputs 0 V or at Supply)						
Si8660Bx, Ex						
V_{DD1}		$V_I = 0(\text{Bx}), 1(\text{Ex})$	—	1.2	1.9	mA
V_{DD2}		$V_I = 0(\text{Bx}), 1(\text{Ex})$	—	3.5	5.3	
V_{DD1}		$V_I = 1(\text{Bx}), 0(\text{Ex})$	—	8.8	12.3	
V_{DD2}		$V_I = 1(\text{Bx}), 0(\text{Ex})$	—	3.7	5.6	
Si8661Bx, Ex						
V_{DD1}		$V_I = 0(\text{Bx}), 1(\text{Ex})$	—	1.7	2.7	mA
V_{DD2}		$V_I = 0(\text{Bx}), 1(\text{Ex})$	—	3.4	5.1	
V_{DD1}		$V_I = 1(\text{Bx}), 0(\text{Ex})$	—	7.9	11.1	
V_{DD2}		$V_I = 1(\text{Bx}), 0(\text{Ex})$	—	4.8	7.2	
Si8662Bx, Ex						
V_{DD1}		$V_I = 0(\text{Bx}), 1(\text{Ex})$	—	2.2	3.3	mA
V_{DD2}		$V_I = 0(\text{Bx}), 1(\text{Ex})$	—	3.0	4.5	
V_{DD1}		$V_I = 1(\text{Bx}), 0(\text{Ex})$	—	7.5	10.5	
V_{DD2}		$V_I = 1(\text{Bx}), 0(\text{Ex})$	—	5.6	8.4	
Si8663Bx, Ex						
V_{DD1}		$V_I = 0(\text{Bx}), 1(\text{Ex})$	—	2.6	3.9	mA
V_{DD2}		$V_I = 0(\text{Bx}), 1(\text{Ex})$	—	2.6	3.9	
V_{DD1}		$V_I = 1(\text{Bx}), 0(\text{Ex})$	—	6.5	9.1	
V_{DD2}		$V_I = 1(\text{Bx}), 0(\text{Ex})$	—	6.5	9.1	
1 Mbps Supply Current (All inputs = 500 kHz square wave, CI = 15 pF on all outputs)						
Si8660Bx, Ex						
V_{DD1}			—	5.0	7.0	mA
V_{DD2}			—	4.2	5.9	
Si8661Bx, Ex						
V_{DD1}			—	4.9	6.9	mA
V_{DD2}			—	4.6	6.4	
Si8662Bx, Ex						
V_{DD1}			—	5.1	7.1	mA
V_{DD2}			—	4.7	6.6	
Si8663Bx, Ex						
V_{DD1}			—	4.9	6.8	mA
V_{DD2}			—	4.9	6.8	
Notes:						
1. The nominal output impedance of an isolator driver channel is approximately $50\ \Omega$, $\pm 40\%$, which is a combination of the value of the on-chip series termination resistor and channel resistance of the output driver FET. When driving loads where transmission line effects will be a factor, output pins should be appropriately terminated with controlled impedance PCB traces.						
2. $t_{PSK(P-P)}$ is the magnitude of the difference in propagation delay times measured between different units operating at the same supply voltages, load, and ambient temperature.						
3. Start-up time is the time period from the application of power to valid data at the output.						

Si8660/61/62/63

Table 2. Electrical Characteristics (Continued)

($V_{DD1} = 5\text{ V} \pm 10\%$, $V_{DD2} = 5\text{ V} \pm 10\%$, $T_A = -40\text{ to }125\text{ }^\circ\text{C}$)

Parameter	Symbol	Test Condition	Min	Typ	Max	Unit
10 Mbps Supply Current (All inputs = 5 MHz square wave, CI = 15 pF on all outputs)						
Si8660Bx, Ex V_{DD1} V_{DD2}			— —	5.0 5.9	7.0 8.3	mA
Si8661Bx, Ex V_{DD1} V_{DD2}			— —	5.2 6.1	7.3 8.5	mA
Si8662Bx, Ex V_{DD1} V_{DD2}			— —	5.6 5.9	7.9 8.2	mA
Si8663Bx, Ex V_{DD1} V_{DD2}			— —	5.7 5.7	8.0 8.0	mA
100 Mbps Supply Current (All inputs = 50 MHz square wave, CI = 15 pF on all outputs)						
Si8660Bx, Ex V_{DD1} V_{DD2}			— —	5.0 26.2	7.0 34.1	mA
Si8661Bx, Ex V_{DD1} V_{DD2}			— —	8.8 23	11.8 29.8	mA
Si8662Bx, Ex V_{DD1} V_{DD2}			— —	12.8 19.4	16.6 25.2	mA
Si8663Bx, Ex V_{DD1} V_{DD2}			— —	16.4 16.4	21.3 21.3	mA
Notes:						
<ol style="list-style-type: none"> 1. The nominal output impedance of an isolator driver channel is approximately $50\ \Omega$, $\pm 40\%$, which is a combination of the value of the on-chip series termination resistor and channel resistance of the output driver FET. When driving loads where transmission line effects will be a factor, output pins should be appropriately terminated with controlled impedance PCB traces. 2. $t_{PSK(P-P)}$ is the magnitude of the difference in propagation delay times measured between different units operating at the same supply voltages, load, and ambient temperature. 3. Start-up time is the time period from the application of power to valid data at the output. 						

Table 2. Electrical Characteristics (Continued) $(V_{DD1} = 5\text{ V} \pm 10\%, V_{DD2} = 5\text{ V} \pm 10\%, T_A = -40\text{ to }125\text{ }^\circ\text{C})$

Parameter	Symbol	Test Condition	Min	Typ	Max	Unit
Timing Characteristics						
Si866xBx, Ex						
Maximum Data Rate			0	—	150	Mbps
Minimum Pulse Width			—	—	5.0	ns
Propagation Delay	t_{PHL}, t_{PLH}	See Figure 1	5.0	8.0	13	ns
Pulse Width Distortion $ t_{PLH} - t_{PHL} $	PWD	See Figure 1	—	0.2	4.5	ns
Propagation Delay Skew ²	$t_{PSK(P-P)}$		—	2.0	4.5	ns
Channel-Channel Skew	t_{PSK}		—	0.4	2.5	ns
All Models						
Output Rise Time	t_r	$C_L = 15\text{ pF}$ (See Figure 1)	—	2.5	4.0	ns
Output Fall Time	t_f	$C_L = 15\text{ pF}$ (See Figure 1)	—	2.5	4.0	ns
Peak Eye Diagram Jitter	$t_{JIT(PK)}$	See Figure 7	—	350	—	ps
Common Mode Transient Immunity	CMTI	$V_I = V_{DD}$ or 0 V $V_{CM} = 1500\text{ V}$ (See Figure 2)	35	50	—	kV/ μs
Startup Time ³	t_{SU}		—	15	40	μs
Notes:						
1. The nominal output impedance of an isolator driver channel is approximately $50\ \Omega$, $\pm 40\%$, which is a combination of the value of the on-chip series termination resistor and channel resistance of the output driver FET. When driving loads where transmission line effects will be a factor, output pins should be appropriately terminated with controlled impedance PCB traces.						
2. $t_{PSK(P-P)}$ is the magnitude of the difference in propagation delay times measured between different units operating at the same supply voltages, load, and ambient temperature.						
3. Start-up time is the time period from the application of power to valid data at the output.						

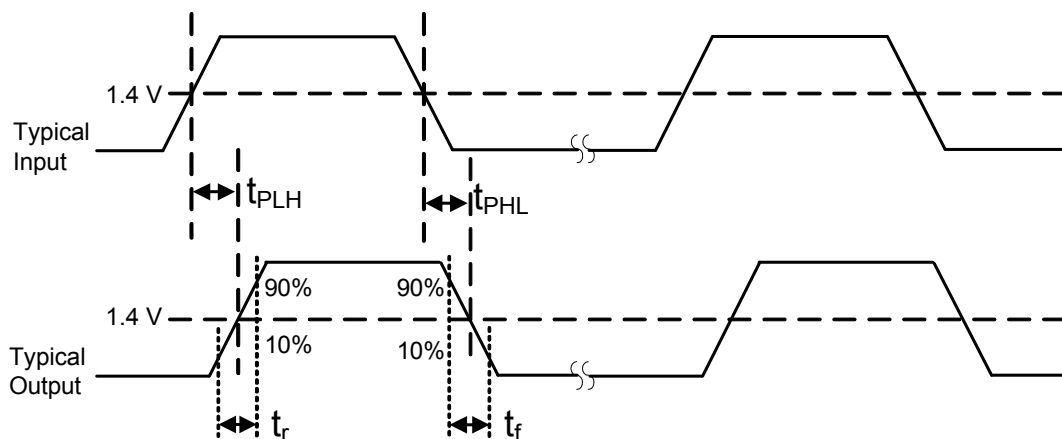
**Figure 1. Propagation Delay Timing**

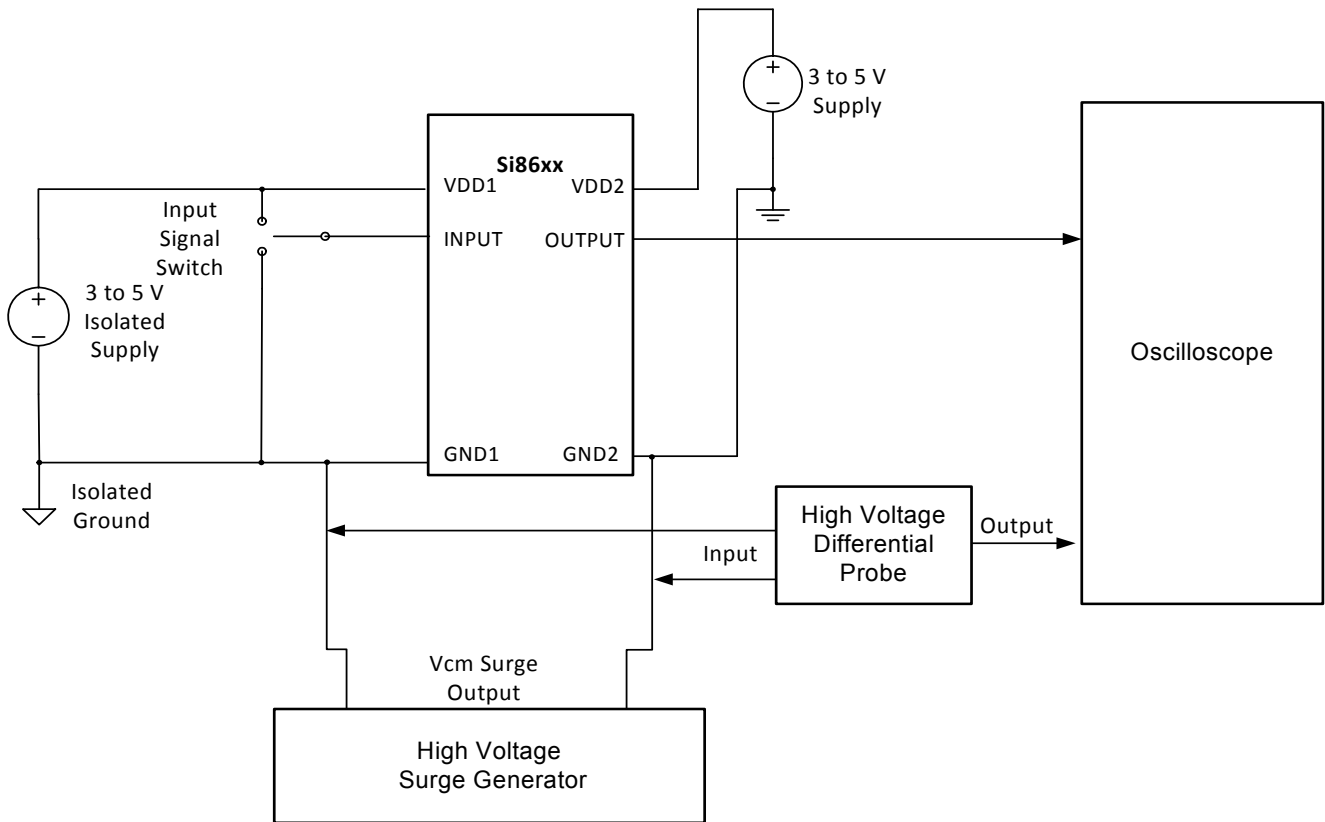

Figure 2. Common Mode Transient Immunity Test Circuit

Table 3. Electrical Characteristics $(V_{DD1} = 3.3\text{ V} \pm 10\%, V_{DD2} = 3.3\text{ V} \pm 10\%, T_A = -40\text{ to }125\text{ }^\circ\text{C})$

Parameter	Symbol	Test Condition	Min	Typ	Max	Unit
VDD Undervoltage Threshold	VDDUV+	V_{DD1}, V_{DD2} rising	1.95	2.24	2.375	V
VDD Undervoltage Threshold	VDDUV-	V_{DD1}, V_{DD2} falling	1.88	2.16	2.325	V
VDD Undervoltage Hysteresis	VDD _{HYS}		50	70	95	mV
Positive-Going Input Threshold	VT+	All inputs rising	1.4	1.67	1.9	V
Negative-Going Input Threshold	VT-	All inputs falling	1.0	1.23	1.4	V
Input Hysteresis	V _{HYS}		0.38	0.44	0.50	V
High Level Input Voltage	V _{IH}		2.0	—	—	V
Low Level Input Voltage	V _{IL}		—	—	0.8	V
High Level Output Voltage	V _{OH}	$I_{OH} = -4\text{ mA}$	$V_{DD1}, V_{DD2} - 0.4$	3.1	—	V
Low Level Output Voltage	V _{OL}	$I_{OL} = 4\text{ mA}$	—	0.2	0.4	V
Input Leakage Current	I _L		—	—	±10	μA
Output Impedance ¹	Z _O		—	50	—	Ω

Notes:

1. The nominal output impedance of an isolator driver channel is approximately 50 Ω, ±40%, which is a combination of the value of the on-chip series termination resistor and channel resistance of the output driver FET. When driving loads where transmission line effects will be a factor, output pins should be appropriately terminated with controlled impedance PCB traces.
2. $t_{PSK(P-P)}$ is the magnitude of the difference in propagation delay times measured between different units operating at the same supply voltages, load, and ambient temperature.
3. Start-up time is the time period from the application of power to valid data at the output.

Si8660/61/62/63

Table 3. Electrical Characteristics (Continued)

($V_{DD1} = 3.3\text{ V} \pm 10\%$, $V_{DD2} = 3.3\text{ V} \pm 10\%$, $T_A = -40\text{ to }125\text{ }^\circ\text{C}$)

Parameter	Symbol	Test Condition	Min	Typ	Max	Unit
DC Supply Current (All inputs 0 V or at supply)						
Si8660Bx, Ex						
V_{DD1}		$V_I = 0(\text{Bx}), 1(\text{Ex})$	—	1.2	1.9	mA
V_{DD2}		$V_I = 0(\text{Bx}), 1(\text{Ex})$	—	3.5	5.3	
V_{DD1}		$V_I = 1(\text{Bx}), 0(\text{Ex})$	—	8.8	12.3	
V_{DD2}		$V_I = 1(\text{Bx}), 0(\text{Ex})$	—	3.7	5.6	
Si8661Bx, Ex						
V_{DD1}		$V_I = 0(\text{Bx}), 1(\text{Ex})$	—	1.7	2.7	mA
V_{DD2}		$V_I = 0(\text{Bx}), 1(\text{Ex})$	—	3.4	5.1	
V_{DD1}		$V_I = 1(\text{Bx}), 0(\text{Ex})$	—	7.9	11.1	
V_{DD2}		$V_I = 1(\text{Bx}), 0(\text{Ex})$	—	4.8	7.2	
Si8662Bx, Ex						
V_{DD1}		$V_I = 0(\text{Bx}), 1(\text{Ex})$	—	2.2	3.3	mA
V_{DD2}		$V_I = 0(\text{Bx}), 1(\text{Ex})$	—	3.0	4.5	
V_{DD1}		$V_I = 1(\text{Bx}), 0(\text{Ex})$	—	7.5	10.5	
V_{DD2}		$V_I = 1(\text{Bx}), 0(\text{Ex})$	—	5.6	8.4	
Si8663Bx, Ex						
V_{DD1}		$V_I = 0(\text{Bx}), 1(\text{Ex})$	—	2.6	3.9	mA
V_{DD2}		$V_I = 0(\text{Bx}), 1(\text{Ex})$	—	2.6	3.9	
V_{DD1}		$V_I = 1(\text{Bx}), 0(\text{Ex})$	—	6.5	9.1	
V_{DD2}		$V_I = 1(\text{Bx}), 0(\text{Ex})$	—	6.5	9.1	
Notes:						
<ol style="list-style-type: none"> 1. The nominal output impedance of an isolator driver channel is approximately $50\ \Omega$, $\pm 40\%$, which is a combination of the value of the on-chip series termination resistor and channel resistance of the output driver FET. When driving loads where transmission line effects will be a factor, output pins should be appropriately terminated with controlled impedance PCB traces. 2. $t_{PSK(P-P)}$ is the magnitude of the difference in propagation delay times measured between different units operating at the same supply voltages, load, and ambient temperature. 3. Start-up time is the time period from the application of power to valid data at the output. 						

Table 3. Electrical Characteristics (Continued) $(V_{DD1} = 3.3\text{ V} \pm 10\%$, $V_{DD2} = 3.3\text{ V} \pm 10\%$, $T_A = -40\text{ to }125\text{ }^\circ\text{C}$)

Parameter	Symbol	Test Condition	Min	Typ	Max	Unit
1 Mbps Supply Current (All inputs = 500 kHz square wave, CI = 15 pF on all outputs)						
Si8660Bx, Ex						
V_{DD1}			—	5.0	7.0	mA
V_{DD2}			—	4.2	5.9	
Si8661Bx, Ex						
V_{DD1}			—	4.9	6.9	mA
V_{DD2}			—	4.6	6.4	
Si8662Bx, Ex						
V_{DD1}			—	5.1	7.1	mA
V_{DD2}			—	4.7	6.6	
Si8663Bx, Ex						
V_{DD1}			—	4.9	6.8	mA
V_{DD2}			—	4.9	6.8	
10 Mbps Supply Current (All inputs = 5 MHz square wave, CI = 15 pF on all outputs)						
Si8660Bx, Ex						
V_{DD1}			—	5.0	7.0	mA
V_{DD2}			—	5.0	7.0	
Si8661Bx, Ex						
V_{DD1}			—	5.0	7.0	mA
V_{DD2}			—	5.3	7.4	
Si8662Bx, Ex						
V_{DD1}			—	5.3	7.4	mA
V_{DD2}			—	5.2	7.3	
Si8663Bx, Ex						
V_{DD1}			—	5.2	7.3	mA
V_{DD2}			—	5.2	7.3	
Notes:						
<ol style="list-style-type: none"> 1. The nominal output impedance of an isolator driver channel is approximately $50\ \Omega$, $\pm 40\%$, which is a combination of the value of the on-chip series termination resistor and channel resistance of the output driver FET. When driving loads where transmission line effects will be a factor, output pins should be appropriately terminated with controlled impedance PCB traces. 2. $t_{PSK(P-P)}$ is the magnitude of the difference in propagation delay times measured between different units operating at the same supply voltages, load, and ambient temperature. 3. Start-up time is the time period from the application of power to valid data at the output. 						

Si8660/61/62/63

Table 3. Electrical Characteristics (Continued)

($V_{DD1} = 3.3\text{ V} \pm 10\%$, $V_{DD2} = 3.3\text{ V} \pm 10\%$, $T_A = -40\text{ to }125\text{ }^\circ\text{C}$)

Parameter	Symbol	Test Condition	Min	Typ	Max	Unit
100 Mbps Supply Current (All inputs = 50 MHz square wave, CI = 15 pF on all outputs)						
Si8660Bx, Ex						
V_{DD1}			—	5.0	7.0	mA
V_{DD2}			—	18.3	23.8	
Si8661Bx, Ex						
V_{DD1}			—	7.4	9.9	mA
V_{DD2}			—	16.4	21.3	
Si8662Bx, Ex						
V_{DD1}			—	10	13	mA
V_{DD2}			—	14.1	18.3	
Si8663Bx, Ex						
V_{DD1}			—	12.3	15.9	mA
V_{DD2}			—	12.3	15.9	
Timing Characteristics						
Si866xBx, Ex						
Maximum Data Rate			0	—	150	Mbps
Minimum Pulse Width			—	—	5.0	ns
Propagation Delay	t_{PHL}, t_{PLH}	See Figure 1	5.0	8.0	13	ns
Pulse Width Distortion $ t_{PLH} - t_{PHL} $	PWD	See Figure 1	—	0.2	4.5	ns
Propagation Delay Skew ²	$t_{PSK(P-P)}$		—	2.0	4.5	ns
Channel-Channel Skew	t_{PSK}		—	0.4	2.5	ns
All Models						
Output Rise Time	t_r	$C_L = 15\text{ pF}$ See Figure 1	—	2.5	4.0	ns
Output Fall Time	t_f	$C_L = 15\text{ pF}$ See Figure 1	—	2.5	4.0	ns
Peak Eye Diagram Jitter	$t_{JIT(PK)}$	See Figure 7	—	350	—	ps
Common Mode Transient Immunity	CMTI	$V_I = V_{DD}$ or 0 V $V_{CM} = 1500\text{ V}$ (see Figure 2)	35	50	—	kV/ μ s
Startup Time ³	t_{SU}		—	15	40	μ s
Notes:						
<ol style="list-style-type: none"> 1. The nominal output impedance of an isolator driver channel is approximately $50\ \Omega$, $\pm 40\%$, which is a combination of the value of the on-chip series termination resistor and channel resistance of the output driver FET. When driving loads where transmission line effects will be a factor, output pins should be appropriately terminated with controlled impedance PCB traces. 2. $t_{PSK(P-P)}$ is the magnitude of the difference in propagation delay times measured between different units operating at the same supply voltages, load, and ambient temperature. 3. Start-up time is the time period from the application of power to valid data at the output. 						

Table 4. Electrical Characteristics(V_{DD1} = 2.5 V ±5%, V_{DD2} = 2.5 V ±5%, T_A = -40 to 125 °C)

Parameter	Symbol	Test Condition	Min	Typ	Max	Unit
VDD Undervoltage Threshold	VDDUV+	V _{DD1} , V _{DD2} rising	1.95	2.24	2.375	V
VDD Undervoltage Threshold	VDDUV-	V _{DD1} , V _{DD2} falling	1.88	2.16	2.325	V
VDD Undervoltage Hysteresis	VDD _{HYS}		50	70	95	mV
Positive-Going Input Threshold	VT+	All inputs rising	1.4	1.67	1.9	V
Negative-Going Input Threshold	VT-	All inputs falling	1.0	1.23	1.4	V
Input Hysteresis	V _{HYS}		0.38	0.44	0.50	V
High Level Input Voltage	V _{IH}		2.0	—	—	V
Low Level Input Voltage	V _{IL}		—	—	0.8	V
High Level Output Voltage	V _{OH}	I _{oh} = -4 mA	V _{DD1} , V _{DD2} - 0.4	2.3	—	V
Low Level Output Voltage	V _{OL}	I _{ol} = 4 mA	—	0.2	0.4	V
Input Leakage Current	I _L		—	—	±10	µA
Output Impedance ¹	Z _O		—	50	—	Ω

Notes:

1. The nominal output impedance of an isolator driver channel is approximately 50 Ω, ±40%, which is a combination of the value of the on-chip series termination resistor and channel resistance of the output driver FET. When driving loads where transmission line effects will be a factor, output pins should be appropriately terminated with controlled impedance PCB traces.
2. t_{PSK(P-P)} is the magnitude of the difference in propagation delay times measured between different units operating at the same supply voltages, load, and ambient temperature.
3. Start-up time is the time period from the application of power to valid data at the output.

Si8660/61/62/63

Table 4. Electrical Characteristics (Continued)

($V_{DD1} = 2.5\text{ V} \pm 5\%$, $V_{DD2} = 2.5\text{ V} \pm 5\%$, $T_A = -40\text{ to }125\text{ }^\circ\text{C}$)

Parameter	Symbol	Test Condition	Min	Typ	Max	Unit
DC Supply Current (All inputs 0 V or at supply)						
Si8660Bx, Ex						
V_{DD1}		$V_I = 0(\text{Bx}), 1(\text{Ex})$	—	1.2	1.9	mA
V_{DD2}		$V_I = 0(\text{Bx}), 1(\text{Ex})$	—	3.5	5.3	
V_{DD1}		$V_I = 1(\text{Bx}), 0(\text{Ex})$	—	8.8	12.3	
V_{DD2}		$V_I = 1(\text{Bx}), 0(\text{Ex})$	—	3.7	5.6	
Si8661Bx, Ex						
V_{DD1}		$V_I = 0(\text{Bx}), 1(\text{Ex})$	—	1.7	2.7	mA
V_{DD2}		$V_I = 0(\text{Bx}), 1(\text{Ex})$	—	3.4	5.1	
V_{DD1}		$V_I = 1(\text{Bx}), 0(\text{Ex})$	—	7.9	11.1	
V_{DD2}		$V_I = 1(\text{Bx}), 0(\text{Ex})$	—	4.8	7.2	
Si8662Bx, Ex						
V_{DD1}		$V_I = 0(\text{Bx}), 1(\text{Ex})$	—	2.2	3.3	mA
V_{DD2}		$V_I = 0(\text{Bx}), 1(\text{Ex})$	—	3.0	4.5	
V_{DD1}		$V_I = 1(\text{Bx}), 0(\text{Ex})$	—	7.5	10.5	
V_{DD2}		$V_I = 1(\text{Bx}), 0(\text{Ex})$	—	5.6	8.4	
Si8663Bx, Ex						
V_{DD1}		$V_I = 0(\text{Bx}), 1(\text{Ex})$	—	2.6	3.9	mA
V_{DD2}		$V_I = 0(\text{Bx}), 1(\text{Ex})$	—	2.6	3.9	
V_{DD1}		$V_I = 1(\text{Bx}), 0(\text{Ex})$	—	6.5	9.1	
V_{DD2}		$V_I = 1(\text{Bx}), 0(\text{Ex})$	—	6.5	9.1	
Notes:						
<ol style="list-style-type: none"> 1. The nominal output impedance of an isolator driver channel is approximately $50\ \Omega$, $\pm 40\%$, which is a combination of the value of the on-chip series termination resistor and channel resistance of the output driver FET. When driving loads where transmission line effects will be a factor, output pins should be appropriately terminated with controlled impedance PCB traces. 2. $t_{PSK(P-P)}$ is the magnitude of the difference in propagation delay times measured between different units operating at the same supply voltages, load, and ambient temperature. 3. Start-up time is the time period from the application of power to valid data at the output. 						

Table 4. Electrical Characteristics (Continued) $(V_{DD1} = 2.5\text{ V} \pm 5\%, V_{DD2} = 2.5\text{ V} \pm 5\%, T_A = -40\text{ to }125\text{ }^\circ\text{C})$

Parameter	Symbol	Test Condition	Min	Typ	Max	Unit
1 Mbps Supply Current (All inputs = 500 kHz square wave, CI = 15 pF on all outputs)						
Si8660Bx, Ex						
V_{DD1}			—	5.0	7.0	mA
V_{DD2}			—	4.2	5.9	
Si8661Bx, Ex						
V_{DD1}			—	4.9	6.9	mA
V_{DD2}			—	4.6	6.4	
Si8662Bx, Ex						
V_{DD1}			—	5.1	7.1	mA
V_{DD2}			—	4.7	6.6	
Si8663Bx, Ex						
V_{DD1}			—	4.9	6.8	mA
V_{DD2}			—	4.9	6.8	
10 Mbps Supply Current (All inputs = 5 MHz square wave, CI = 15 pF on all outputs)						
Si8660Bx, Ex						
V_{DD1}			—	5.0	7.0	mA
V_{DD2}			—	4.6	6.4	
Si8661Bx, Ex						
V_{DD1}			—	5.0	6.9	mA
V_{DD2}			—	4.9	6.9	
Si8662Bx, Ex						
V_{DD1}			—	5.2	7.2	mA
V_{DD2}			—	4.9	6.9	
Si8663Bx, Ex						
V_{DD1}			—	5.0	7.0	mA
V_{DD2}			—	5.0	7.0	
Notes:						
<ol style="list-style-type: none"> 1. The nominal output impedance of an isolator driver channel is approximately $50\ \Omega$, $\pm 40\%$, which is a combination of the value of the on-chip series termination resistor and channel resistance of the output driver FET. When driving loads where transmission line effects will be a factor, output pins should be appropriately terminated with controlled impedance PCB traces. 2. $t_{PSK(P-P)}$ is the magnitude of the difference in propagation delay times measured between different units operating at the same supply voltages, load, and ambient temperature. 3. Start-up time is the time period from the application of power to valid data at the output. 						

Si8660/61/62/63

Table 4. Electrical Characteristics (Continued)

($V_{DD1} = 2.5\text{ V} \pm 5\%$, $V_{DD2} = 2.5\text{ V} \pm 5\%$, $T_A = -40\text{ to }125\text{ }^\circ\text{C}$)

Parameter	Symbol	Test Condition	Min	Typ	Max	Unit
100 Mbps Supply Current (All inputs = 50 MHz square wave, CI = 15 pF on all outputs)						
Si8660Bx, Ex V_{DD1} V_{DD2}			— —	5.0 14.7	7.0 19.1	mA
Si8661Bx, Ex V_{DD1} V_{DD2}			— —	6.7 13.4	9.1 17.4	mA
Si8662Bx, Ex V_{DD1} V_{DD2}			— —	8.7 11.7	11.3 15.2	mA
Si8663Bx, Ex V_{DD1} V_{DD2}			— —	10.3 10.3	13.4 13.4	mA
Timing Characteristics						
Si866xBx, Ex						
Maximum Data Rate			0	—	150	Mbps
Minimum Pulse Width			—	—	5.0	ns
Propagation Delay	t_{PHL} , t_{PLH}	See Figure 1	5.0	8.0	14	ns
Pulse Width Distortion $ t_{PLH} - t_{PHL} $	PWD	See Figure 1	—	0.2	5.0	ns
Propagation Delay Skew ²	$t_{PSK(P-P)}$		—	2.0	5.0	ns
Channel-Channel Skew	t_{PSK}		—	0.4	2.5	ns
All Models						
Output Rise Time	t_r	$C_L = 15\text{ pF}$ See Figure 1	—	2.5	4.0	ns
Output Fall Time	t_f	$C_L = 15\text{ pF}$ See Figure 1	—	2.5	4.0	ns
Peak Eye Diagram Jitter	$t_{JIT(PK)}$	See Figure 7	—	350	—	ps
Common Mode Transient Immunity	CMTI	$V_I = V_{DD}$ or 0 V $V_{CM} = 1500\text{ V}$ (see Figure 2)	35	50	—	kV/ μ s
Startup Time ³	t_{SU}		—	15	40	μ s
Notes:						
<ol style="list-style-type: none"> 1. The nominal output impedance of an isolator driver channel is approximately $50\ \Omega$, $\pm 40\%$, which is a combination of the value of the on-chip series termination resistor and channel resistance of the output driver FET. When driving loads where transmission line effects will be a factor, output pins should be appropriately terminated with controlled impedance PCB traces. 2. $t_{PSK(P-P)}$ is the magnitude of the difference in propagation delay times measured between different units operating at the same supply voltages, load, and ambient temperature. 3. Start-up time is the time period from the application of power to valid data at the output. 						

Table 5. Regulatory Information*

CSA
The Si866x is certified under CSA Component Acceptance Notice 5A. For more details, see File 232873.
61010-1: Up to 600 V _{RMS} reinforced insulation working voltage; up to 600 V _{RMS} basic insulation working voltage.
60950-1: Up to 600 V _{RMS} reinforced insulation working voltage; up to 1000 V _{RMS} basic insulation working voltage.
60601-1: Up to 125 V _{RMS} reinforced insulation working voltage; up to 380 V _{RMS} basic insulation working voltage.
VDE
The Si866x is certified according to IEC 60747-5-2. For more details, see File 5006301-4880-0001.
60747-5-2: Up to 1200 V _{peak} for basic insulation working voltage.
60950-1: Up to 600 V _{RMS} reinforced insulation working voltage; up to 1000 V _{RMS} basic insulation working voltage.
UL
The Si866x is certified under UL1577 component recognition program. For more details, see File E257455.
Rated up to 5000 V _{RMS} isolation voltage for basic protection.
CQC
The Si866x is certified under GB4943.1-2011. For more details, see certificates CQC13001096110 and CQC13001096239.
Rated up to 600 V _{RMS} reinforced insulation working voltage; up to 1000 V _{RMS} basic insulation working voltage.
*Note: Regulatory Certifications apply to 2.5 kV _{RMS} rated devices which are production tested to 3.0 kV _{RMS} for 1 sec. Regulatory Certifications apply to 3.75 kV _{RMS} rated devices which are production tested to 4.5 kV _{RMS} for 1 sec. Regulatory Certifications apply to 5.0 kV _{RMS} rated devices which are production tested to 6.0 kV _{RMS} for 1 sec. For more information, see "5. Ordering Guide" on page 30.

Table 6. Insulation and Safety-Related Specifications

Parameter	Symbol	Test Condition	Value		Unit
			WB SOIC-16	NB SOIC-16	
Nominal Air Gap (Clearance) ¹	L(IO1)		8.0	4.9	mm
Nominal External Tracking (Creepage) ¹	L(IO2)		8.0	4.01	mm
Minimum Internal Gap (Internal Clearance)			0.014	0.014	mm
Tracking Resistance (Proof Tracking Index)	PTI	IEC60112	600	600	V _{RMS}
Erosion Depth	ED		0.019	0.019	mm
Resistance (Input-Output) ²	R _{IO}		10 ¹²	10 ¹²	Ω
Capacitance (Input-Output) ²	C _{IO}	f = 1 MHz	2.0	2.0	pF
Input Capacitance ³	C _I		4.0	4.0	pF

Notes:

- The values in this table correspond to the nominal creepage and clearance values. VDE certifies the clearance and creepage limits as 4.7 mm minimum for the NB SOIC-16 package and 8.5 mm minimum for the WB SOIC-16 package. UL does not impose a clearance and creepage minimum for component-level certifications. CSA certifies the clearance and creepage limits as 3.9 mm minimum for the NB SOIC-16 package and 7.6 mm minimum for the WB SOIC-16 package.
- To determine resistance and capacitance, the Si86xx is converted into a 2-terminal device. Pins 1–8 are shorted together to form the first terminal and pins 9–16 are shorted together to form the second terminal. The parameters are then measured between these two terminals.
- Measured from input pin to ground.

Table 7. IEC 60664-1 (VDE 0844 Part 2) Ratings

Parameter	Test Conditions	Specification	
		NB SOIC-16	WB SOIC-16
Basic Isolation Group	Material Group	I	I
Installation Classification	Rated Mains Voltages $\leq 150 V_{RMS}$	I-IV	I-IV
	Rated Mains Voltages $\leq 300 V_{RMS}$	I-III	I-IV
	Rated Mains Voltages $\leq 400 V_{RMS}$	I-II	I-III
	Rated Mains Voltages $\leq 600 V_{RMS}$	I-II	I-III

Table 8. IEC 60747-5-2 Insulation Characteristics for Si86xxxx*

Parameter	Symbol	Test Condition	Characteristic		Unit
			WB SOIC-16	NB SOIC-16	
Maximum Working Insulation Voltage	V_{IORM}		1200	630	Vpeak
Input to Output Test Voltage	V_{PR}	Method b1 ($V_{IORM} \times 1.875 = V_{PR}$, 100% Production Test, $t_m = 1$ sec, Partial Discharge < 5 pC)	2250	1182	
Transient Overvoltage	V_{IOTM}	$t = 60$ sec	6000	6000	Vpeak
Pollution Degree (DIN VDE 0110, Table 1)			2	2	
Insulation Resistance at T_S , $V_{IO} = 500$ V	R_S		$>10^9$	$>10^9$	Ω

*Note: Maintenance of the safety data is ensured by protective circuits. The Si86xxxx provides a climate classification of 40/125/21.

Table 9. IEC Safety Limiting Values¹

Parameter	Symbol	Test Condition	Max		Unit
			WB SOIC-16	NB SOIC-16	
Case Temperature	T_S		150	150	$^{\circ}C$
Safety Input, Output, or Supply Current	I_S	$\theta_{JA} = 105$ $^{\circ}C/W$ (NB SOIC-16), $V_I = 5.5$ V, $T_J = 150$ $^{\circ}C$, $T_A = 25$ $^{\circ}C$	220	215	mA
Device Power Dissipation ²	P_D		415	415	mW

Notes:

1. Maximum value allowed in the event of a failure; also see the thermal derating curve in Figures 3 and 4.
2. The Si86xx is tested with $VDD1 = VDD2 = 5.5$ V, $T_J = 150$ $^{\circ}C$, $C_L = 15$ pF, input a 150 Mbps 50% duty cycle square wave.

Table 10. Thermal Characteristics

Parameter	Symbol	WB SOIC-16	NB SOIC-16	Unit
IC Junction-to-Air Thermal Resistance	θ_{JA}	100	105	$^{\circ}\text{C}/\text{W}$

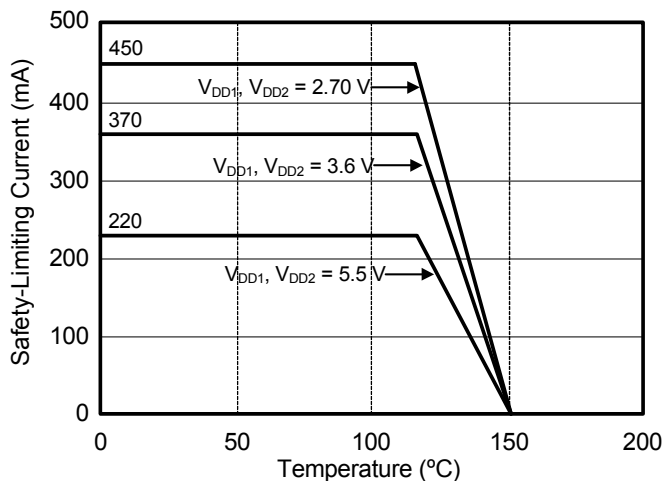

Figure 3. (WB SOIC-16) Thermal Derating Curve, Dependence of Safety Limiting Values with Case Temperature per DIN EN 60747-5-2

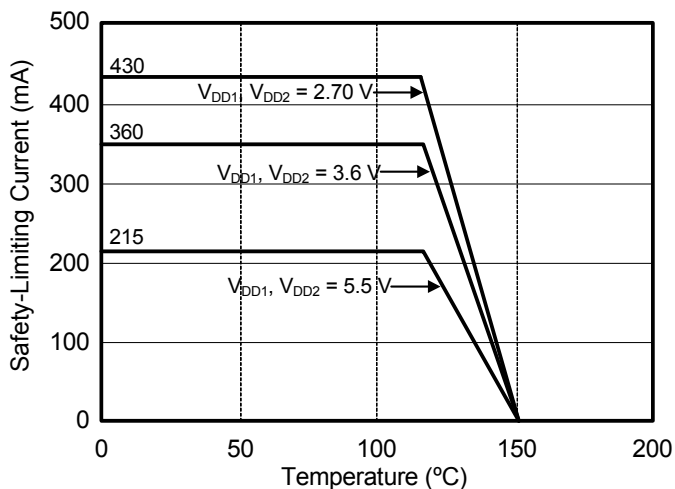

Figure 4. (NB SOIC-16) Thermal Derating Curve, Dependence of Safety Limiting Values with Case Temperature per DIN EN 60747-5-2

Table 11. Absolute Maximum Ratings¹

Parameter	Symbol	Min	Max	Unit
Storage Temperature ²	T_{STG}	-65	150	°C
Ambient Temperature Under Bias	T_A	-40	125	°C
Junction Temperature	T_J	—	150	°C
Supply Voltage	V_{DD1}, V_{DD2}	-0.5	7.0	V
Input Voltage	V_I	-0.5	$V_{DD} + 0.5$	V
Output Voltage	V_O	-0.5	$V_{DD} + 0.5$	V
Output Current Drive Channel	I_O	—	10	mA
Lead Solder Temperature (10 s)		—	260	°C
Maximum Isolation (Input to Output) (1 sec) NB SOIC-16		—	4500	V_{RMS}
Maximum Isolation (Input to Output) (1 sec) WB SOIC-16		—	6500	V_{RMS}
Notes:				
1. Permanent device damage may occur if the absolute maximum ratings are exceeded. Functional operation should be restricted to conditions as specified in the operational sections of this data sheet.				
2. VDE certifies storage temperature from -40 to 150 °C.				

2. Functional Description

2.1. Theory of Operation

The operation of an Si866x channel is analogous to that of an opto coupler, except an RF carrier is modulated instead of light. This simple architecture provides a robust isolated data path and requires no special considerations or initialization at start-up. A simplified block diagram for a single Si866x channel is shown in Figure 5.

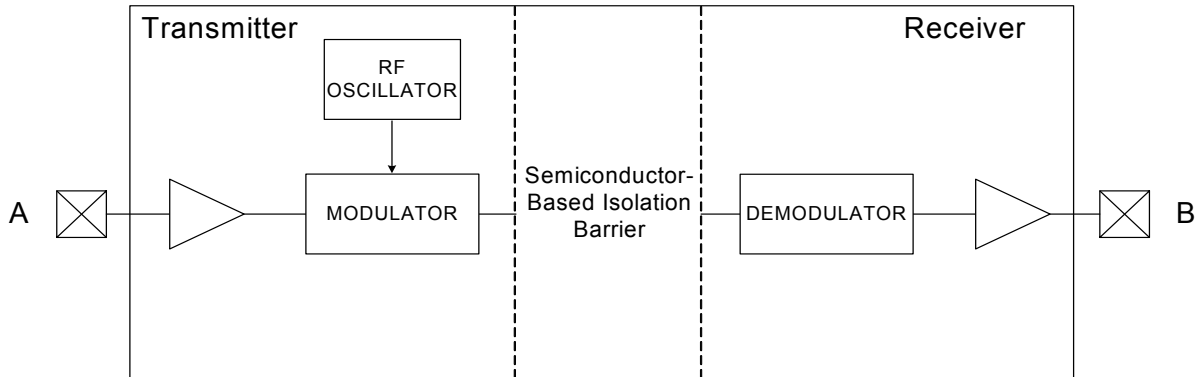

Figure 5. Simplified Channel Diagram

A channel consists of an RF Transmitter and RF Receiver separated by a semiconductor-based isolation barrier. Referring to the Transmitter, input A modulates the carrier provided by an RF oscillator using on/off keying. The Receiver contains a demodulator that decodes the input state according to its RF energy content and applies the result to output B via the output driver. This RF on/off keying scheme is superior to pulse code schemes as it provides best-in-class noise immunity, low power consumption, and better immunity to magnetic fields. See Figure 6 for more details.

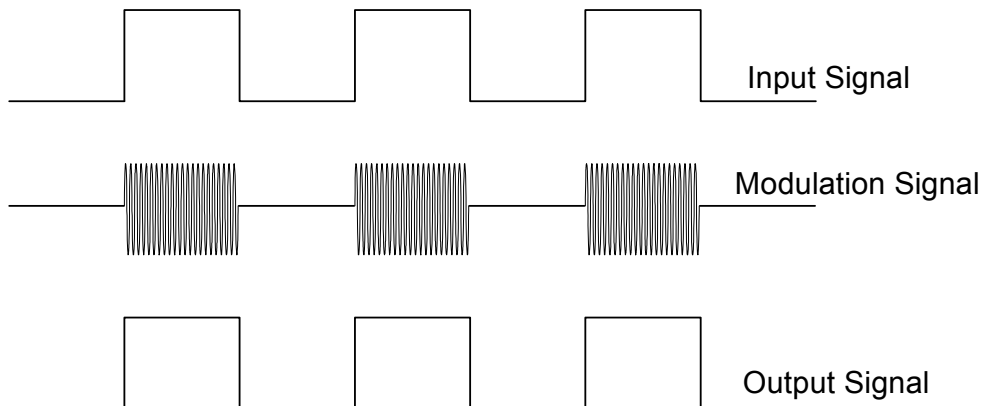

Figure 6. Modulation Scheme

2.2. Eye Diagram

Figure 7 illustrates an eye-diagram taken on an Si8660. For the data source, the test used an Anritsu (MP1763C) Pulse Pattern Generator set to 1000 ns/div. The output of the generator's clock and data from an Si8660 were captured on an oscilloscope. The results illustrate that data integrity was maintained even at the high data rate of 150 Mbps. The results also show that 2 ns pulse width distortion and 350 ps peak jitter were exhibited.

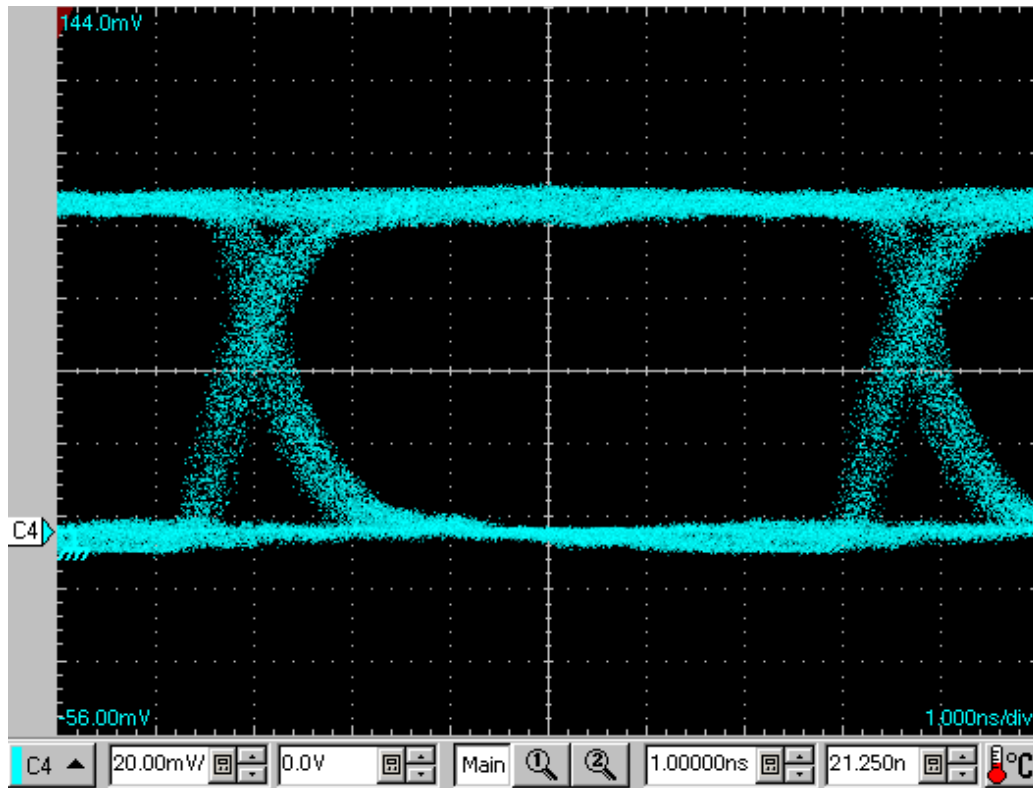

Figure 7. Eye Diagram

3. Device Operation

Device behavior during start-up, normal operation, and shutdown is shown in Figure 8, where UVLO+ and UVLO- are the positive-going and negative-going thresholds respectively. Refer to Table 12 to determine outputs when power supply (VDD) is not present.

Table 12. Si866x Logic Operation

V _I Input ^{1,2}	VDDI State ^{1,3,4}	VDDO State ^{1,3,4}	V _O Output ^{1,2}	Comments
H	P	P	H	Normal operation.
L	P	P	L	
X ⁵	UP	P	L ⁶ H ⁶	Upon transition of VDDI from unpowered to powered, V _O returns to the same state as V _I in less than 1 μs.
X ⁵	P	UP	Undetermined	Upon transition of VDDO from unpowered to powered, V _O returns to the same state as V _I within 1 μs.

Notes:

1. VDDI and VDDO are the input and output power supplies. V_I and V_O are the respective input and output terminals.
2. X = not applicable; H = Logic High; L = Logic Low; Hi-Z = High Impedance.
3. "Powered" state (P) is defined as 2.5 V < VDD < 5.5 V.
4. "Unpowered" state (UP) is defined as VDD = 0 V.
5. Note that an I/O can power the die for a given side through an internal diode if its source has adequate current.
6. See "5. Ordering Guide" on page 30 for details. This is the selectable fail-safe operating mode (ordering option). Some devices have default output state = H, and some have default output state = L, depending on the ordering part number (OPN). For default high devices, the data channels have pull-ups on inputs/outputs. For default low devices, the data channels have pull-downs on inputs/outputs.

3.1. Device Startup

Outputs are held low during powerup until VDD is above the UVLO threshold for time period t_{START} . Following this, the outputs follow the states of inputs.

3.2. Undervoltage Lockout

Undervoltage Lockout (UVLO) is provided to prevent erroneous operation during device startup and shutdown or when VDD is below its specified operating circuits range. Both Side A and Side B each have their own undervoltage lockout monitors. Each side can enter or exit UVLO independently. For example, Side A unconditionally enters UVLO when V_{DD1} falls below $V_{DD1(UVLO-)}$ and exits UVLO when V_{DD1} rises above $V_{DD1(UVLO+)}$. Side B operates the same as Side A with respect to its V_{DD2} supply.

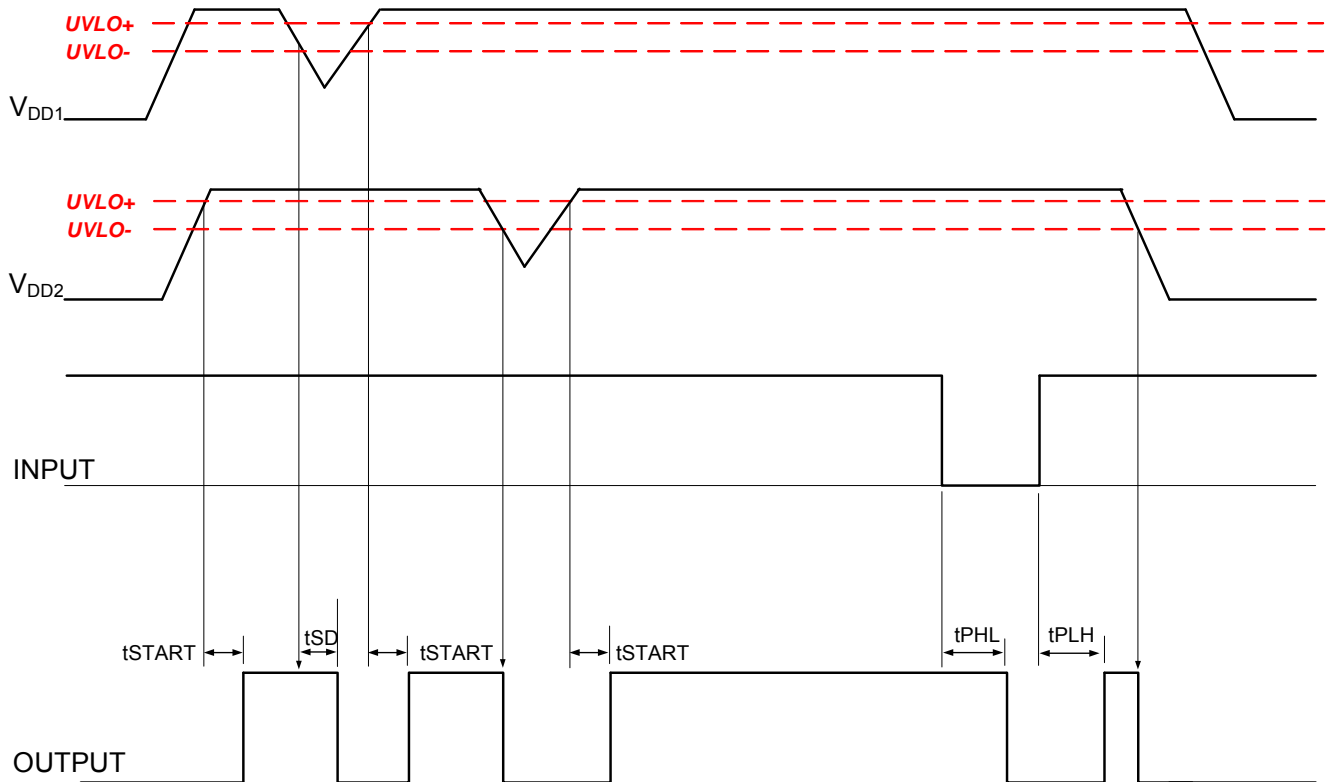

Figure 8. Device Behavior during Normal Operation

3.3. Layout Recommendations

To ensure safety in the end user application, high voltage circuits (i.e., circuits with $>30 V_{AC}$) must be physically separated from the safety extra-low voltage circuits (SELV is a circuit with $<30 V_{AC}$) by a certain distance (creepage/clearance). If a component, such as a digital isolator, straddles this isolation barrier, it must meet those creepage/clearance requirements and also provide a sufficiently large high-voltage breakdown protection rating (commonly referred to as working voltage protection). Table 5 on page 17 and Table 6 on page 18 detail the working voltage and creepage/clearance capabilities of the Si86xx. These tables also detail the component standards (UL1577, IEC60747, CSA 5A), which are readily accepted by certification bodies to provide proof for end-system specifications requirements. Refer to the end-system specification (61010-1, 60950-1, 60601-1, etc.) requirements before starting any design that uses a digital isolator.

3.3.1. Supply Bypass

The Si866x family requires a $0.1 \mu F$ bypass capacitor between V_{DD1} and GND1 and V_{DD2} and GND2. The capacitor should be placed as close as possible to the package. To enhance the robustness of a design, the user may also include resistors ($50\text{--}300 \Omega$) in series with the inputs and outputs if the system is excessively noisy.

3.3.2. Output Pin Termination

The nominal output impedance of an isolator driver channel is approximately 50Ω , $\pm 40\%$, which is a combination of the value of the on-chip series termination resistor and channel resistance of the output driver FET. When driving loads where transmission line effects will be a factor, output pins should be appropriately terminated with controlled impedance PCB traces.

3.4. Fail-Safe Operating Mode

Si86xx devices feature a selectable (by ordering option) mode whereby the default output state (when the input supply is unpowered) can either be a logic high or logic low when the output supply is powered. See Table 12 on page 24 and "5. Ordering Guide" on page 30 for more information.

3.5. Typical Performance Characteristics

The typical performance characteristics depicted in the following diagrams are for information purposes only. Refer to Tables 2, 3, and 4 for actual specification limits.

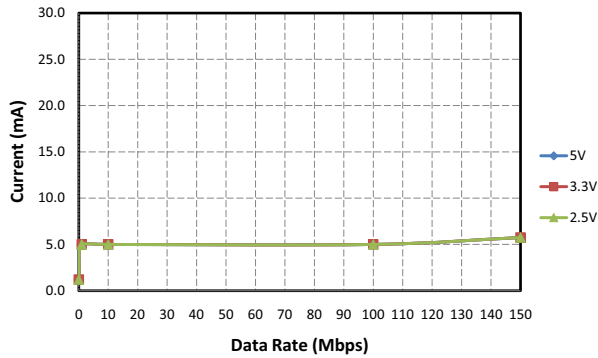

Figure 9. Si8660 Typical V_{DD1} Supply Current vs. Data Rate 5, 3.3, and 2.5 V Operation

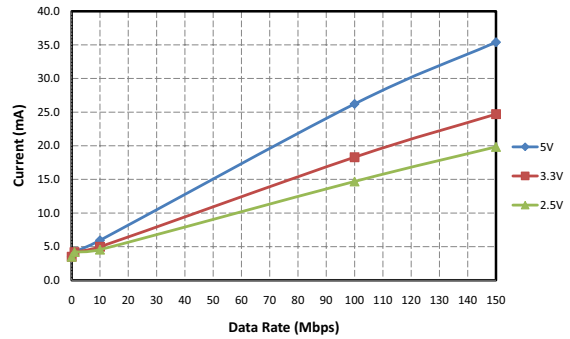

Figure 12. Si8660 Typical V_{DD2} Supply Current vs. Data Rate 5, 3.3, and 2.5 V Operation (15 pF Load)

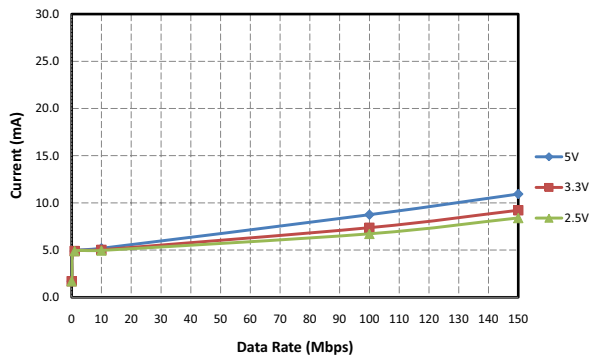

Figure 10. Si8661 Typical V_{DD1} Supply Current vs. Data Rate 5, 3.3, and 2.5 V Operation (15 pF Load)

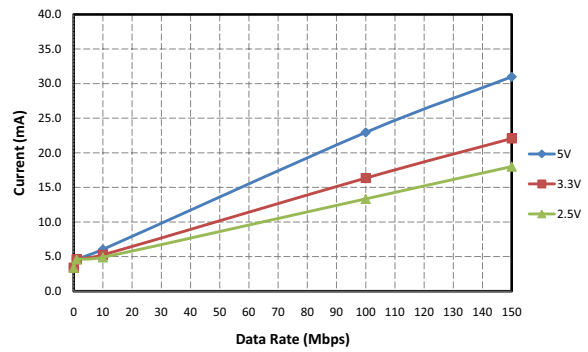

Figure 13. Si8661 Typical V_{DD2} Supply Current vs. Data Rate 5, 3.3, and 2.5 V Operation (15 pF Load)

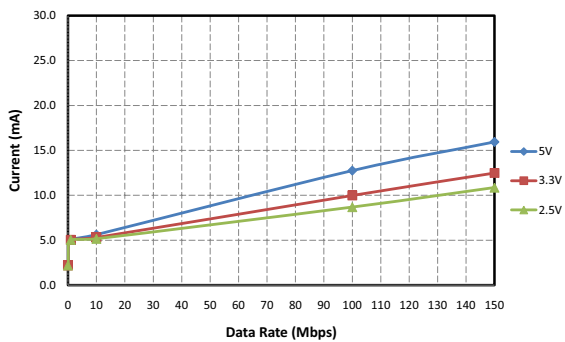

Figure 11. Si8662 Typical V_{DD1} Supply Current vs. Data Rate 5, 3.3, and 2.5 V Operation (15 pF Load)

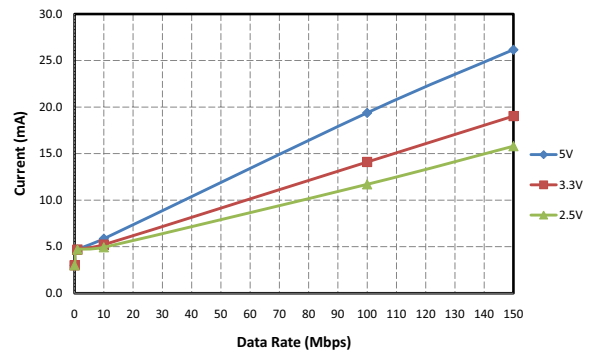

Figure 14. Si8662 Typical V_{DD2} Supply Current vs. Data Rate 5, 3.3, and 2.5 V Operation (15 pF Load)

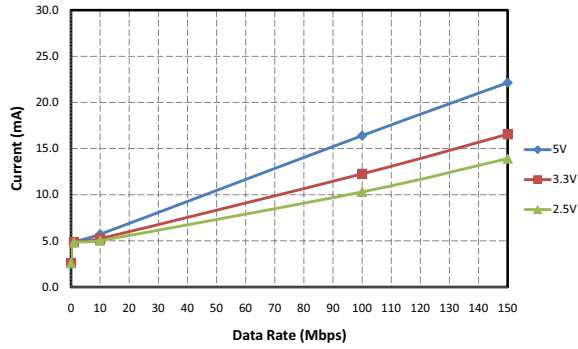

Figure 15. Si8663 Typical V_{DD1} or V_{DD2} Supply Current vs. Data Rate 5, 3.3, and 2.5 V Operation (15 pF Load)

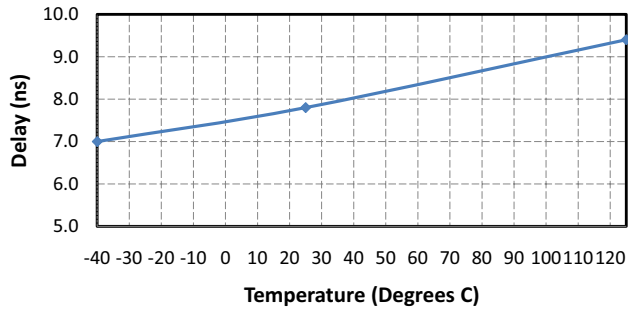
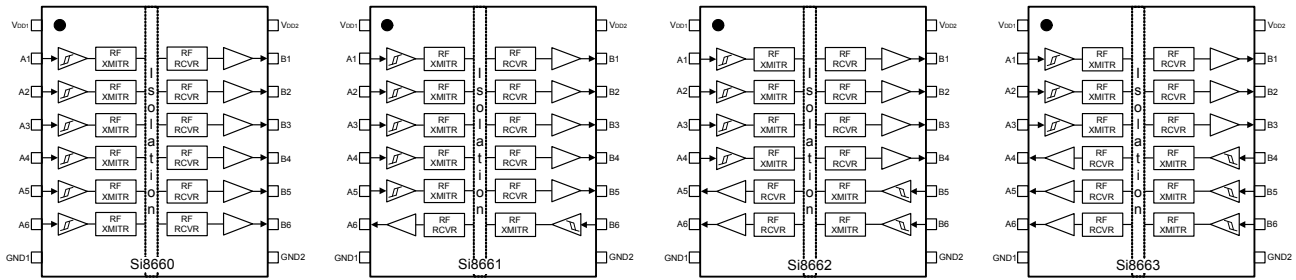

Figure 16. Propagation Delay vs. Temperature

4. Pin Descriptions



Name	SOIC-16 Pin#	Type	Description
V _{DD1}	1	Supply	Side 1 power supply.
A1	2	Digital Input	Side 1 digital input.
A2	3	Digital Input	Side 1 digital input.
A3	4	Digital Input	Side 1 digital input.
A4	5	Digital I/O	Side 1 digital input or output.
A5	6	Digital I/O	Side 1 digital input or output.
A6	7	Digital I/O	Side 1 digital input or output.
GND1	8	Ground	Side 1 ground.
GND2	9	Ground	Side 2 ground.
B6	10	Digital I/O	Side 2 digital input or output.
B5	11	Digital I/O	Side 2 digital input or output.
B4	12	Digital I/O	Side 2 digital input or output.
B3	13	Digital Output	Side 2 digital output.
B2	14	Digital Output	Side 2 digital output.
B1	15	Digital Output	Side 2 digital output.
V _{DD2}	16	Supply	Side 2 power supply.

5. Ordering Guide

Table 13. Ordering Guide for Valid OPNs^{1,2}

Ordering Part Number (OPN)	Number of Inputs VDD1 Side	Number of Inputs VDD2 Side	Max Data Rate (Mbps)	Default Output State	Isolation rating (kV)	Temp (°C)	Package
Si8660BA-B-IS1	6	0	150	Low	1.0	-40 to 125 °C	NB SOIC-16
Si8660BB-B-IS1	6	0	150	Low	2.5	-40 to 125 °C	NB SOIC-16
Si8660BC-B-IS1	6	0	150	Low	3.75	-40 to 125 °C	NB SOIC-16
Si8660EC-B-IS1	6	0	150	High	3.75	-40 to 125 °C	NB SOIC-16
Si8660BD-B-IS	6	0	150	Low	5.0	-40 to 125 °C	WB SOIC-16
Si8660ED-B-IS	6	0	150	High	5.0	-40 to 125 °C	WB SOIC-16
Si8661BB-B-IS1	5	1	150	Low	2.5	-40 to 125 °C	NB SOIC-16
Si8661BC-B-IS1	5	1	150	Low	3.75	-40 to 125 °C	NB SOIC-16
Si8661EC-B-IS1	5	1	150	High	3.75	-40 to 125 °C	NB SOIC-16
Si8661BD-B-IS	5	1	150	Low	5.0	-40 to 125 °C	WB SOIC-16
Si8661ED-B-IS	5	1	150	High	5.0	-40 to 125 °C	WB SOIC-16
Si8662BB-B-IS1	4	2	150	Low	2.5	-40 to 125 °C	NB SOIC-16
Si8662BC-B-IS1	4	2	150	Low	3.75	-40 to 125 °C	NB SOIC-16
Si8662EC-B-IS1	4	2	150	High	3.75	-40 to 125 °C	NB SOIC-16
Si8662BD-B-IS	4	2	150	Low	5.0	-40 to 125 °C	WB SOIC-16
Si8662ED-B-IS	4	2	150	High	5.0	-40 to 125 °C	WB SOIC-16
Si8663BB-B-IS1	3	3	150	Low	2.5	-40 to 125 °C	NB SOIC-16
Si8663BC-B-IS1	3	3	150	Low	3.75	-40 to 125 °C	NB SOIC-16
Si8663EC-B-IS1	3	3	150	High	3.75	-40 to 125 °C	NB SOIC-16
Si8663BD-B-IS	3	3	150	Low	5.0	-40 to 125 °C	WB SOIC-16
Si8663ED-B-IS	3	3	150	High	5.0	-40 to 125 °C	WB SOIC-16

Notes:

1. All packages are RoHS-compliant with peak reflow temperatures of 260 °C according to the JEDEC industry standard classifications and peak solder temperatures.
2. “Si” and “SI” are used interchangeably.

6. Package Outline: 16-Pin Wide Body SOIC

Figure 17 illustrates the package details for the Si866x Digital Isolator. Table 14 lists the values for the dimensions shown in the illustration.

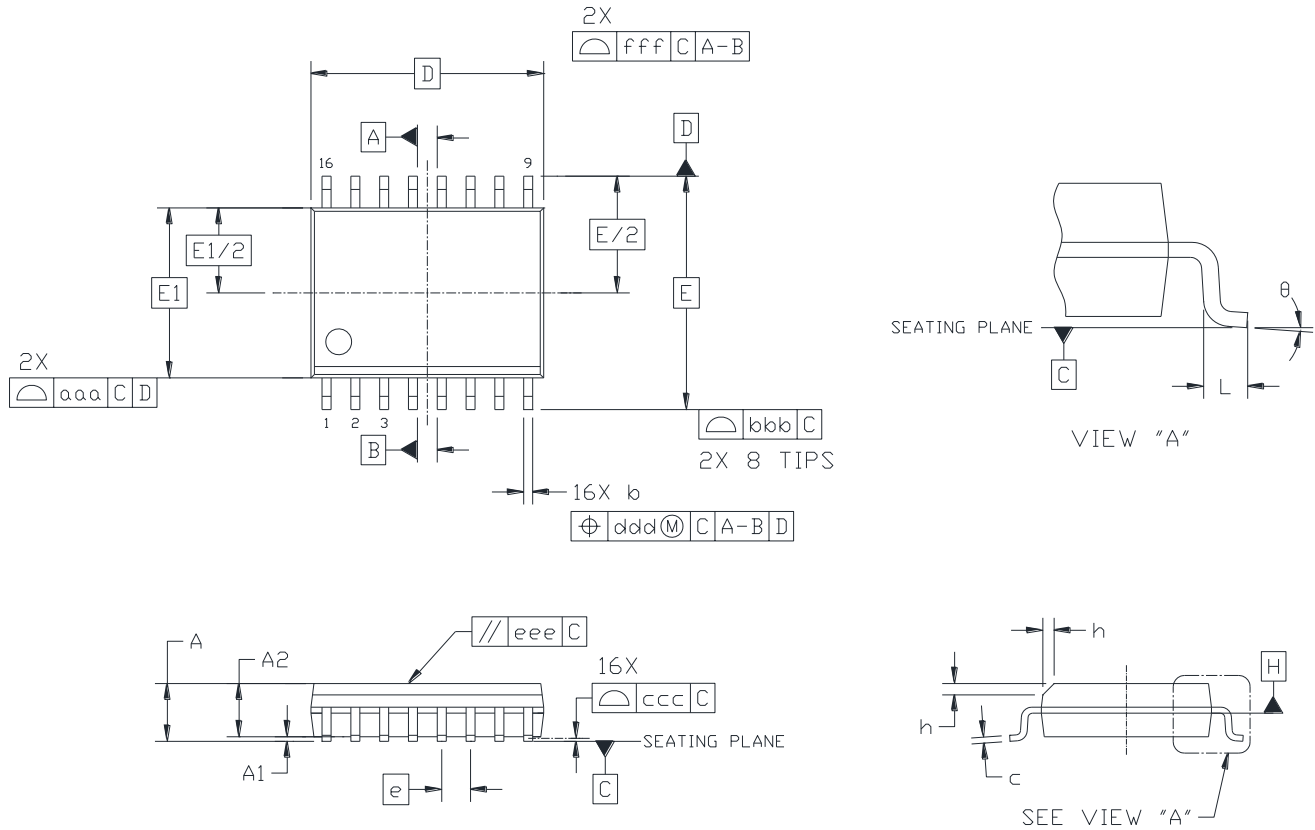

Figure 17. 16-Pin Wide Body SOIC

Table 14. Package Diagram Dimensions

Dimension	Min	Max
A	—	2.65
A1	0.10	0.30
A2	2.05	—
b	0.31	0.51
c	0.20	0.33
D	10.30 BSC	
E	10.30 BSC	
E1	7.50 BSC	
e	1.27 BSC	
L	0.40	1.27
h	0.25	0.75
θ	0°	8°
aaa	—	0.10
bbb	—	0.33
ccc	—	0.10
ddd	—	0.25
eee	—	0.10
fff	—	0.20

Notes:

1. All dimensions shown are in millimeters (mm) unless otherwise noted.
2. Dimensioning and Tolerancing per ANSI Y14.5M-1994.
3. This drawing conforms to JEDEC Outline MS-013, Variation AA.
4. Recommended reflow profile per JEDEC J-STD-020C specification for small body, lead-free components.

7. Land Pattern: 16-Pin Wide-Body SOIC

Figure 18 illustrates the recommended land pattern details for the Si866x in a 16-pin wide-body SOIC. Table 15 lists the values for the dimensions shown in the illustration.

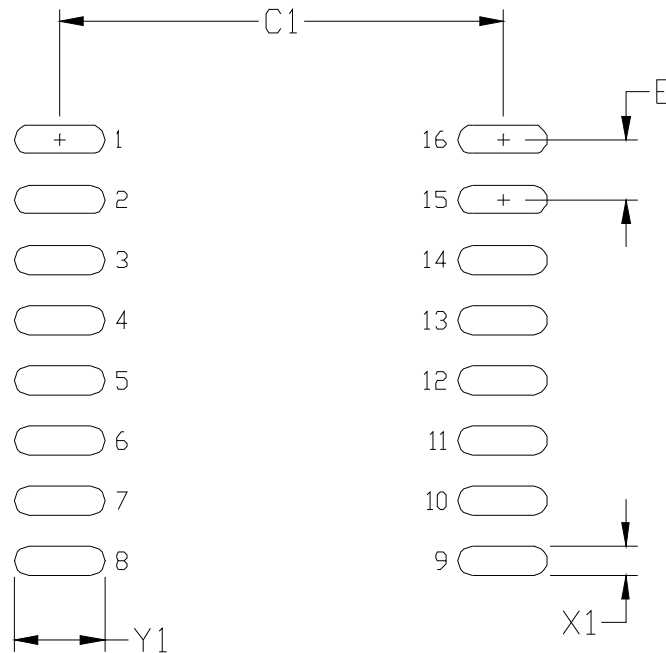

Figure 18. 16-Pin SOIC Land Pattern

Table 15. 16-Pin Wide Body SOIC Land Pattern Dimensions

Dimension	Feature	(mm)
C1	Pad Column Spacing	9.40
E	Pad Row Pitch	1.27
X1	Pad Width	0.60
Y1	Pad Length	1.90

Notes:

1. This Land Pattern Design is based on IPC-7351 pattern SOIC127P1032X265-16AN for Density Level B (Median Land Protrusion).
2. All feature sizes shown are at Maximum Material Condition (MMC) and a card fabrication tolerance of 0.05 mm is assumed.

8. Package Outline: 16-Pin Narrow Body SOIC

Figure 19 illustrates the package details for the Si866x in a 16-pin narrow-body SOIC (SO-16). Table 16 lists the values for the dimensions shown in the illustration.

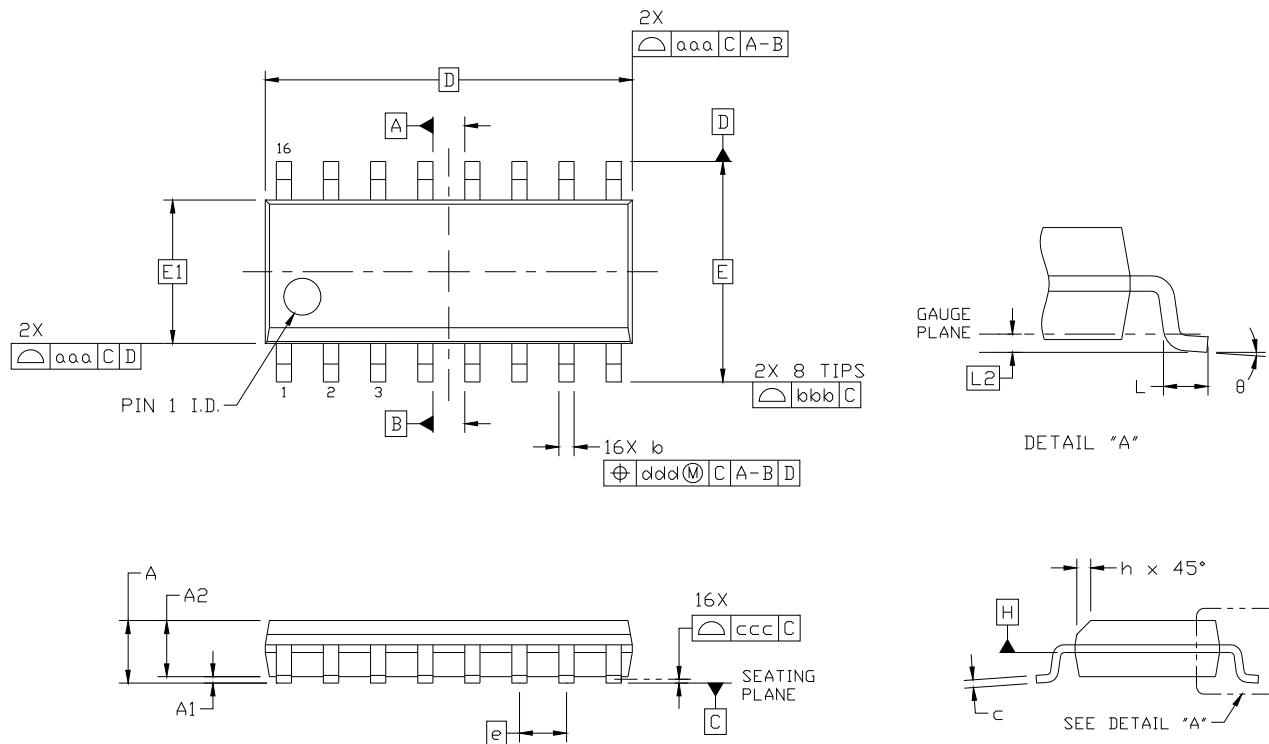

Figure 19. 16-pin Small Outline Integrated Circuit (SOIC) Package

Table 16. Package Diagram Dimensions

Dimension	Min	Max
A	—	1.75
A1	0.10	0.25
A2	1.25	—
b	0.31	0.51
c	0.17	0.25
D	9.90 BSC	
E	6.00 BSC	
E1	3.90 BSC	
e	1.27 BSC	
L	0.40	1.27
L2	0.25 BSC	
h	0.25	0.50
θ	0°	8°
aaa	0.10	
bbb	0.20	
ccc	0.10	
ddd	0.25	
Notes:		
<ol style="list-style-type: none"> 1. All dimensions shown are in millimeters (mm) unless otherwise noted. 2. Dimensioning and Tolerancing per ANSI Y14.5M-1994. 3. This drawing conforms to the JEDEC Solid State Outline MS-012, Variation AC. 4. Recommended card reflow profile is per the JEDEC/IPC J-STD-020 specification for Small Body Components. 		

9. Land Pattern: 16-Pin Narrow Body SOIC

Figure 20 illustrates the recommended land pattern details for the Si866x in a 16-pin narrow-body SOIC. Table 17 lists the values for the dimensions shown in the illustration.

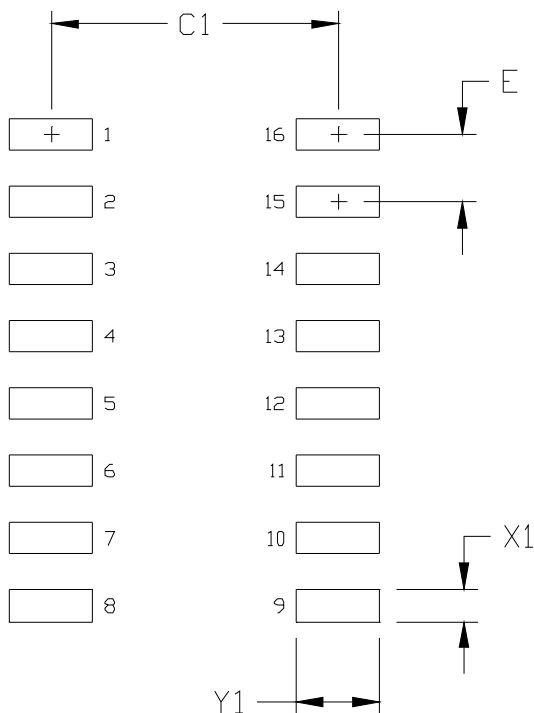

Figure 20. 16-Pin Narrow Body SOIC PCB Land Pattern

Table 17. 16-Pin Narrow Body SOIC Land Pattern Dimensions

Dimension	Feature	(mm)
C1	Pad Column Spacing	5.40
E	Pad Row Pitch	1.27
X1	Pad Width	0.60
Y1	Pad Length	1.55

Notes:

1. This Land Pattern Design is based on IPC-7351 pattern SOIC127P600X165-16N for Density Level B (Median Land Protrusion).
2. All feature sizes shown are at Maximum Material Condition (MMC) and a card fabrication tolerance of 0.05 mm is assumed.

10. Top Markings

10.1. Si866x Top Marking (16-Pin Wide Body SOIC)

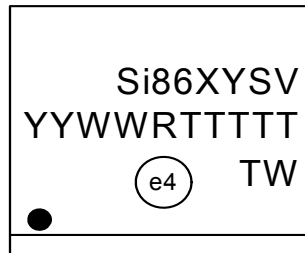

10.2. Top Marking Explanation (16-Pin Wide Body SOIC)

Line 1 Marking:	Base Part Number Ordering Options (See Ordering Guide for more information).	Si86 = Isolator product series XY = Channel Configuration X = # of data channels (6, 5, 4, 3, 2, 1) Y = # of reverse channels (3, 2, 1, 0) S = Speed Grade A = 1 Mbps; B = 150 Mbps (default output = low); E = 150 Mbps (default output = high) V = Insulation rating A = 1 kV; B = 2.5 kV; C = 3.75 kV; D = 5.0 kV
	Line 2 Marking: YY = Year WW = Workweek	Assigned by assembly subcontractor. Corresponds to the year and workweek of the mold date.
Line 3 Marking:	RTTTTT = Mfg Code	Manufacturing code from assembly house "R" indicates revision
	Circle = 1.7 mm Diameter (Center-Justified)	"e4" Pb-Free Symbol
	Country of Origin ISO Code Abbreviation	TW = Taiwan

Si8660/61/62/63

10.3. Si866x Top Marking (16-Pin Narrow Body SOIC)

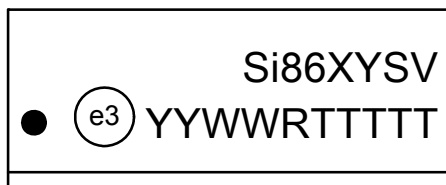

10.4. Top Marking Explanation (16-Pin Narrow Body SOIC)

Line 1 Marking:	Base Part Number Ordering Options (See Ordering Guide for more information).	Si86 = Isolator product series XY = Channel Configuration X = # of data channels (6, 5, 4, 3, 2, 1) Y = # of reverse channels (3, 2, 1, 0) S = Speed Grade A = 1 Mbps; B = 150 Mbps (default output = low); E = 150 Mbps (default output = high) V = Insulation rating A = 1 kV; B = 2.5 kV; C = 3.75 kV
	Line 2 Marking:	
	Circle = 1.2 mm Diameter	"e3" Pb-Free Symbol
	YY = Year WW = Work Week	Assigned by the Assembly House. Corresponds to the year and work week of the mold date.
	RTTTTT = Mfg Code	Manufacturing code from assembly house "R" indicates revision
	Circle = 1.2 mm diameter	"e3" Pb-Free Symbol.

DOCUMENT CHANGE LIST

Revision 0.1 to Revision 1.0

- Added chip graphics on page 1.
- Updated "Features" on page 1.
- Moved Tables 1 and 11 to page 21.
- Updated Tables 2, 3, and 4.
- Updated Table 6, "Insulation and Safety-Related Specifications," on page 18.
- Updated Table 8, "IEC 60747-5-2 Insulation Characteristics for Si86xxxx*," on page 19.
- Moved Table 12 to page 24.
- Moved "Typical Performance Characteristics" to page 27.
- Updated "3.5. Typical Performance Characteristics" on page 27.
- Updated Table 4, "Pin Descriptions," on page 29.
- Updated "5. Ordering Guide" on page 30.
- Removed references to QSOP-16 package.

Revision 1.0 to Revision 1.1

- Reordered spec tables to conform to new convention.
- Removed "pending" throughout document.

Revision 1.1 to Revision 1.2

- Updated High Level Output Voltage V_{OH} to 3.1 V in Table 3, "Electrical Characteristics," on page 9.
- Updated High Level Output Voltage V_{OH} to 2.3 V in Table 4, "Electrical Characteristics," on page 13.

Revision 1.2 to Revision 1.3

- Updated "5. Ordering Guide" on page 30 to include MSL2A.

Revision 1.3 to Revision 1.4

- Updated Table 11 on page 21.
 - Added junction temperature spec.
- Updated "3.3.1. Supply Bypass" on page 26.
- Removed "3.3.2. Pin Connections" on page 22.
- Updated "5. Ordering Guide" on page 30.
 - Removed Rev A devices.
- Updated "6. Package Outline: 16-Pin Wide Body SOIC" on page 31.
- Updated Top Marks.
 - Added revision description.

Revision 1.4 to Revision 1.5

- Added Figure 2, "Common Mode Transient Immunity Test Circuit," on page 8.
- Added references to CQC throughout.
- Added references to 2.5 kV_{RMS} devices throughout.
- Updated "5. Ordering Guide" on page 30.
- Updated "10.1. Si866x Top Marking (16-Pin Wide Body SOIC)" on page 37.

Revision 1.5 to Revision 1.6

- Updated Table 5 on page 17.
 - Added CQC certificate numbers.
- Updated "5. Ordering Guide" on page 30.
 - Removed references to moisture sensitivity levels.
 - Removed note 2.

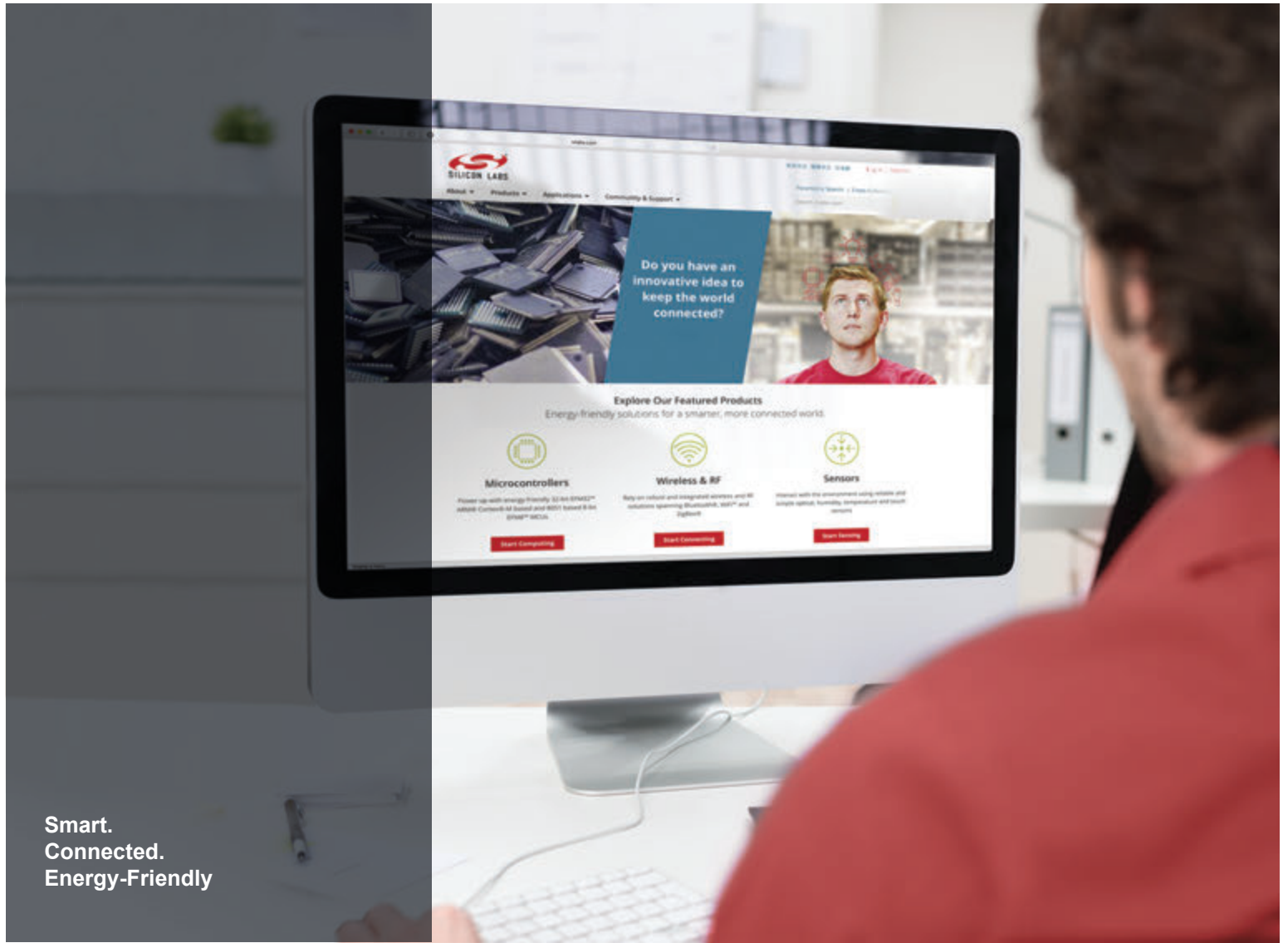

Smart.
Connected.
Energy-Friendly



Products
www.silabs.com/products

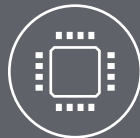

Quality
www.silabs.com/quality



Support and Community
community.silabs.com

Disclaimer
Silicon Labs intends to provide customers with the latest, accurate, and in-depth documentation of all peripherals and modules available for system and software implementers using or intending to use the Silicon Labs products. Characterization data, available modules and peripherals, memory sizes and memory addresses refer to each specific device, and "Typical" parameters provided can and do vary in different applications. Application examples described herein are for illustrative purposes only. Silicon Labs reserves the right to make changes without further notice and limitation to product information, specifications, and descriptions herein, and does not give warranties as to the accuracy or completeness of the included information. Silicon Labs shall have no liability for the consequences of use of the information supplied herein. This document does not imply or express copyright licenses granted hereunder to design or fabricate any integrated circuits. The products are not designed or authorized to be used within any Life Support System without the specific written consent of Silicon Labs. A "Life Support System" is any product or system intended to support or sustain life and/or health, which, if it fails, can be reasonably expected to result in significant personal injury or death. Silicon Labs products are not designed or authorized for military applications. Silicon Labs products shall under no circumstances be used in weapons of mass destruction including (but not limited to) nuclear, biological or chemical weapons, or missiles capable of delivering such weapons.

Trademark Information

Silicon Laboratories Inc.®, Silicon Laboratories®, Silicon Labs®, SiLabs® and the Silicon Labs logo®, Bluegiga®, Bluegiga Logo®, Clockbuilder®, CMEMS®, DSPLL®, EFM®, EFM32®, EFR, Ember®, Energy Micro, Energy Micro logo and combinations thereof, "the world's most energy friendly microcontrollers", Ember®, EZLink®, EZRadio®, EZRadioPRO®, Gecko®, ISOModem®, Precision32®, ProSLIC®, Simplicity Studio®, SiPHY®, Telegesis, the Telegesis Logo®, USBXpress® and others are trademarks or registered trademarks of Silicon Labs. ARM, CORTEX, Cortex-M3 and THUMB are trademarks or registered trademarks of ARM Holdings. Keil is a registered trademark of ARM Limited. All other products or brand names mentioned herein are trademarks of their respective holders.



Silicon Laboratories Inc.
400 West Cesar Chavez
Austin, TX 78701
USA

<http://www.silabs.com>